

EDITION
2024

RELIABLE, EFFICIENT, SCALABLE

DATA CENTER SOLUTIONS

WHITE SPACE ▪ GREY SPACE

CONTENTS

2-3	CORPORATE SOCIAL RESPONSIBILITY
4-5	IMPROVING LIVES
6-7	LEGRAND - A GLOBAL PLAYER
8-9	OUR DATA CENTER OFFER
10-11	CRITICAL POWER:
12-13	CAST RESIN TRANSFORMERS
14-15	HIGH POWER BUSBARS
16-17	SWITCHGEARS
18-21	UPS AND STS SOLUTIONS
22-23	TRACK BUSWAY
24-25	CABLE MANAGEMENT:
26-27	OVERHEAD CABLE MANAGEMENT
28-29	EZ-PATH FIRE RESISTANT DEVICE
30-31	IT INFRASTRUCTURE:
32-33	CONTAINMENT AND COOLING
34-35	ACTIVE COOLING
36-37	SERVER AND NETWORK RACKS & CABINETS
38-39	INTELLIGENT PDU'S AND SENSORS
40-41	KVM & SERIAL CONSOLE
42-43	STRUCTURED CABLING
44-45	CONNECTIVITY FIBER SOLUTION
46-47	DCIM SOFTWARE INTEGRATION
48-49	SUCCESS STORIES





FUTURE PROOF DATA CENTER SOLUTIONS WITH A TRACK RECORD OF CUSTOMER SATISFACTION

The data center industry is in a state of constant transformation, driven by a growing emphasis on sustainability, flexibility, and modularity, alongside an unprecedented demand for compute power. Infrastructure solutions must adapt and evolve to meet these changing requirements. A dependable infrastructure partner must be able to deliver innovative solutions that address the needs of today's data centers and anticipate and cater to the demands of tomorrow.

Legrand is a reliable global partner with over 30 years of experience in delivering expertly engineered solutions that meet the ever-evolving needs of data centers and building networks.

We offer an award-winning portfolio of solutions from industry-leading brands like Legrand, Borri, Cablofil, Compose, Geiger, Minkels, Modulan, Power Control, Raritan, Server Technology, Starline, USystems, Voltadis, and Zucchini, with proven excellence in delivering optimal uptime of mission-critical operations. Our local specialists design and build a comprehensive range of connectivity, physical infrastructure, cable management, power, and cooling solutions to meet your exact requirements.

Quote Option 1:

"As IT Infrastructure needs and buying behavior changes, so too does the technical level of solutions that Legrand offers. Our sustainable solutions support next-generation technologies with modularity and flexibility for future growth and energy and installation efficiencies, united by superior design. With Legrand, you have a reliable partner you can trust to deliver future-proof solutions that meet your exact needs."

**Marc Marazzi, Vice President Legrand
Data Center Solutions Europe**

Quote Option 1:

"As IT infrastructure requirements and buying behavior evolve, so too does Legrand's suite of solutions. Our commitment to sustainability ensures that our offerings support next-generation technologies, offering modularity and flexibility for future scalability while prioritizing energy efficiency and streamlined installation. Rooted in superior design, Legrand is a trusted partner, delivering tailored solutions that anticipate and meet your precise needs, ensuring lasting reliability in an ever-changing landscape."

**Marc Marazzi, Vice President Legrand
Data Center Solutions Europe**





Creating a more sustainable world for everybody

It is our responsibility to provide concrete answers to the major societal challenges of our time, and this requires us to raise awareness not only in our own teams but also among our partners and customers. We need to bring them on board by our side as responsible players acting hand in hand with us. Our commitment to a low-carbon society is matched by our determination to guarantee a better future for our children and generations yet to come. This is why Legrand, leveraging the progress achieved in the framework of its previous roadmaps, now undertakes to intensify yet further its action in favour of an increasingly responsible development of its activities. This ambition is built around a simple and hopeful purpose: improving lives.

Our 4 main areas of action to improve lives

Legrand has laid out its CSR commitments in four main areas, which bring together the most tangible challenges for the Group and its stakeholders:

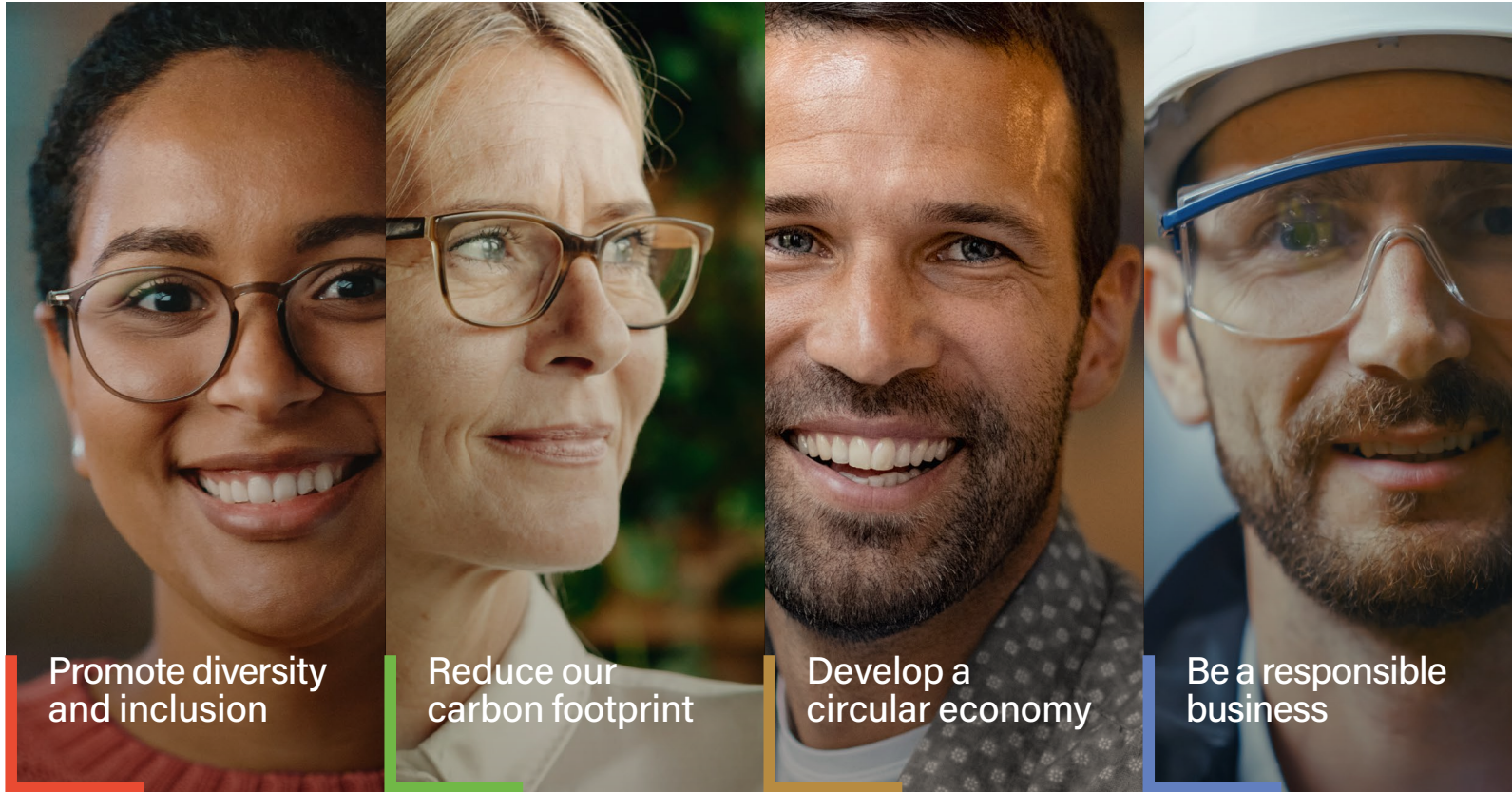

Promote diversity and inclusion

For Legrand, diversity and inclusion are a source of sustainable performance and prosperity.

Reduce our carbon footprint

It is urgent to reduce the Group's carbon footprint in order to fight climate change.

Develop a circular economy

Integrating a circular economy approach into Legrand's activities is a major component of the Group's sustainable development.

Be a responsible business

Acting responsibly means respecting and supporting all stakeholders, including employees and customers.

READ MORE ABOUT OUR CSR STRATEGY ONLINE:



2030 Target

- Reduce carbon emissions related to our own activities by 50% and carbon emissions in our value chain by 15%.
- Achieve 80% of our sales with eco-responsible solutions

2050 Target

- Legrand has set itself the goal of reaching carbon neutrality throughout the Group's value chain.



Legrand takes concrete action to show its commitment to increasingly responsible development.



A young girl with brown hair in two pigtails, wearing large black-rimmed glasses and a white t-shirt. She is holding an orange notebook and looking upwards with a surprised expression, her mouth slightly open. The background is a plain, light-colored wall.

We improve lives

At Legrand, we improve lives by transforming the spaces where people live, work, and meet, with electrical and digital infrastructures and connected solutions that are simple, innovative, and sustainable.

BECAUSE...

- Legrand represents over 150 years of innovation for the benefit of all, delivering more simplicity, more comfort, more security, and more energy efficiency.
- Our systems, solutions and products provide answers to the technological, societal and environmental challenges that we all face every day.
- Our connected, open and interoperable solutions contribute to the digital transformation of all types of buildings.
- We support the development of sustainable buildings.
- Every day we commit to growing engaged teams that are working hard to change society and protect our planet.
- For us, customer satisfaction also means protecting the environment – for this generation and the next.



IMPROVING LIVES BY TRANSFORMING SPACES THAT'S THE ESSENCE OF OUR PURPOSE!

READ MORE ABOUT OUR
PURPOSE ONLINE:

WWW.LEGRANDGROUP.COM/EN/GROUP/OUR-PURPOSE

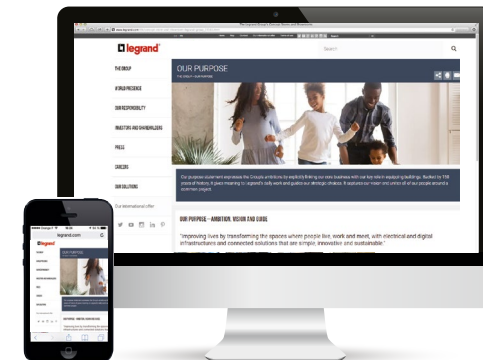

05

Legrand

a global player



Legrand is the global specialist in electrical and digital building infrastructures. The Group offers a comprehensive range of solutions and services tailored to residential, commercial and industrial markets. The scope of its offering and its leading positions make Legrand a worldwide benchmark.



AN ACTIVE INTERNATIONAL PRESENCE

ESTABLISHED
IN OVER
90 COUNTRIES

OVER 38,000
EMPLOYEES



SALES IN
CLOSE TO
180 COUNTRIES

CONTINUOUS INNOVATION

5% OF SALES
DEDICATED TO
R&D EVERY YEAR



TOTAL GROWTH IN SALES 2023

TURNOVER 8.4B€

REDUCTION IN CO2 EMISSIONS

-39% OVER
2 YEARS
(CONSTANT)



CSR ACHIEVEMENT RATE IN 2023

118%

Our DATA CENTER global offer

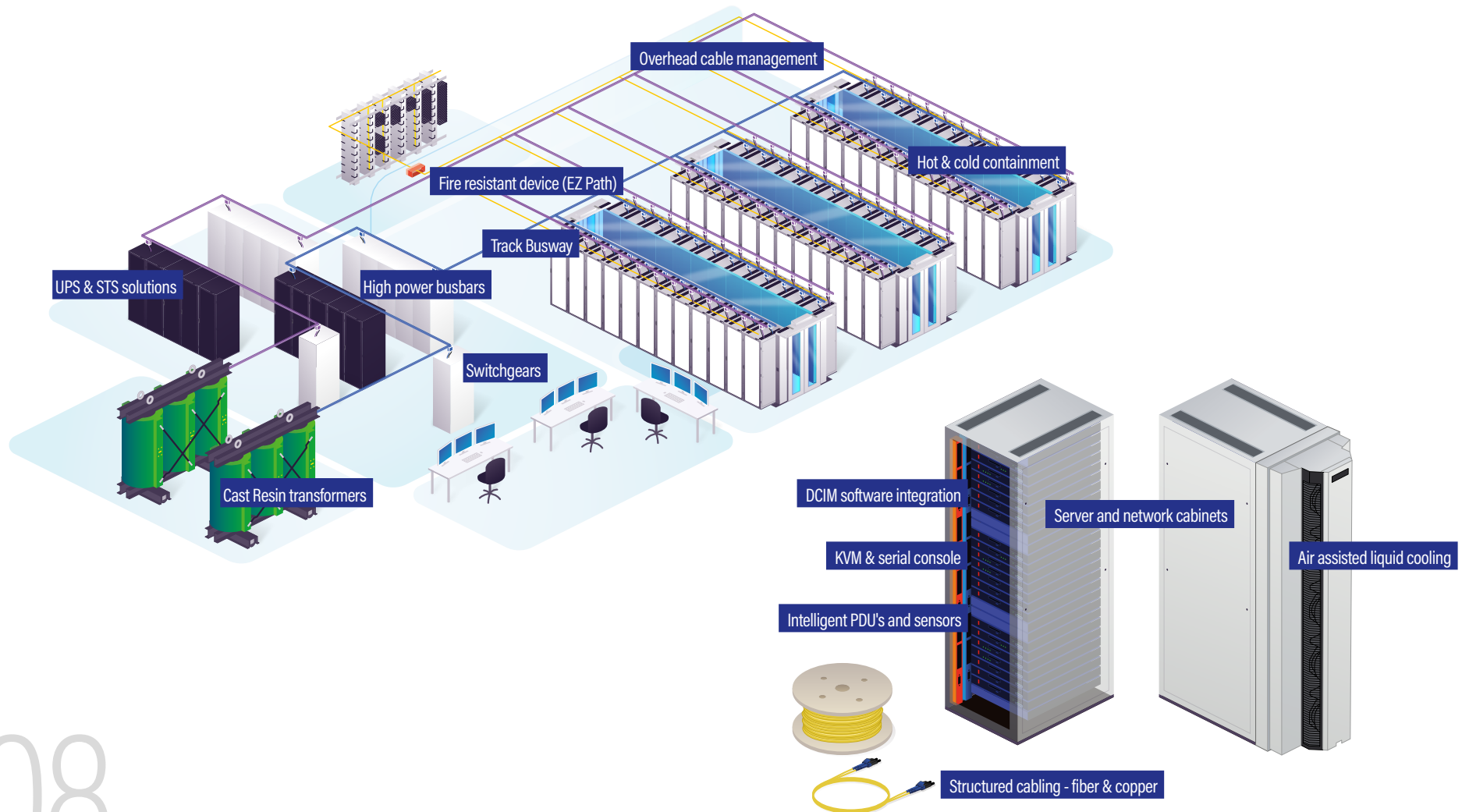

OUR SPECIALIST BRANDS

Covering all your IT infrastructure, cable management, and critical power needs!

With award-winning solutions from strong data center players, you benefit from optimal uptime of mission-critical operations. Our team of local specialists design and build innovative solutions, including enclosures, cooling, power, structured cabling, and access management, to meet your unique requirements.

BORRI **bticino** CABLOFIL *Estap*

GEIGER *inform* **legrand** MINKELS

modulan PowerControl Raritan Server Technology

Starline USystems VOLTADIS ZUGGHINI



09

CRITICAL POWER

CAST RESIN TRANSFORMERS

The Legrand Green T.HE transformers guarantee a significant reduction in energy consumption, promoting significant economic savings and the reduction of CO2 emissions into the atmosphere.

HIGH POWER BUSBARS

The busbar trunking system is ideal for the transport and distribution of energy in data centers. Ranging from 630-6300 amps, the high power busbar is characterized by a smart and ultra-compact design that delivers up to an IP55 degree of protection.

SWITCHGEARS

The right protection for your high-performance installations with an optimum continuity of service.

UPS & STS SOLUTIONS

Legrand propose a UPS&STS range, a complementary offer of technological functions able to guarantee maximum protection and uptime for all systems.

TRACK BUSWAY

Starline Track Busway is the industry-leading electrical power distribution system for data centers.

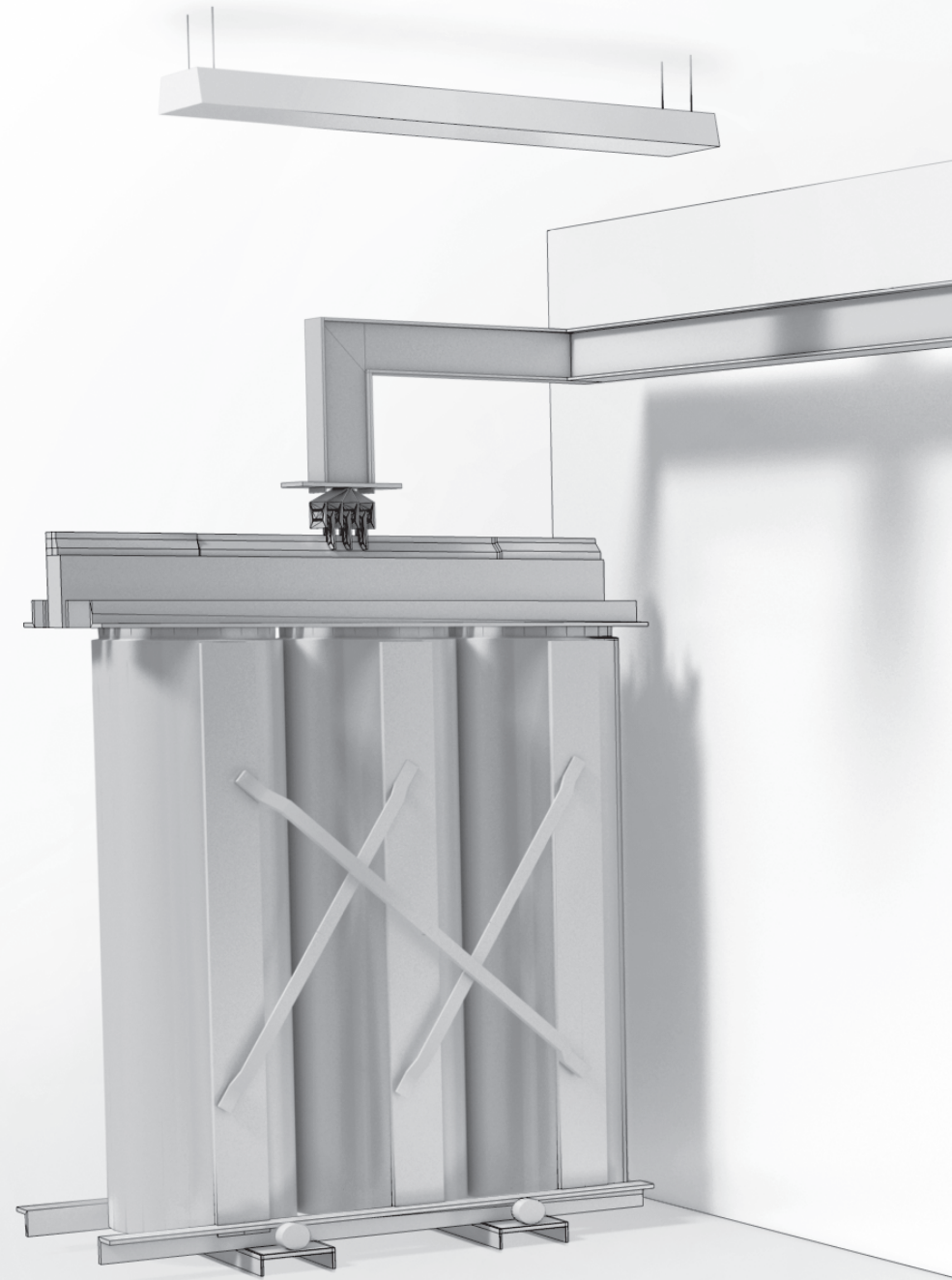

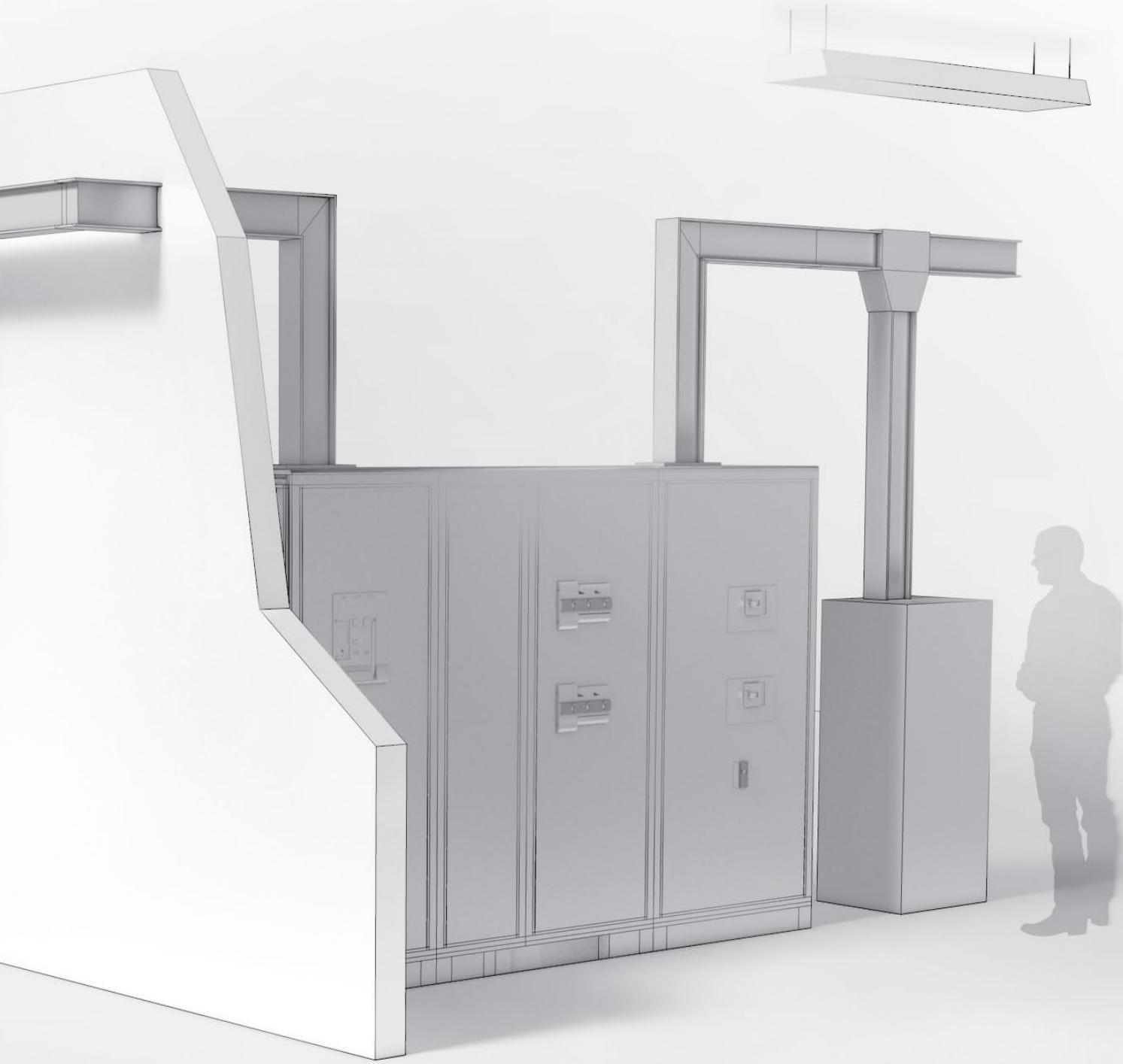

011

CAST RESIN TRANSFORMERS

The Legrand Green T.HE transformers fully comply with the European Commission's Ecodesign Directive and guarantee a significant reduction in energy consumption, thus promoting economic savings and the reduction of CO₂ emissions into the atmosphere.



LEGRAND powered by ZUCCHINI

With the Green T.HE series (tier 2), Legrand offers its customers a very high quality product, with excellent performance and reduced losses, in full compliance with regulation 548/2014 and subsequent updates (EU regulation 2019/1783).

FEATURES

- Power ratings from 50kVA up to 20MVA
- Aluminium and copper winding options
- Class E3 C2 F1 and E4 (on-request)
- Ucc of 6%
- Meets the requirements of the EcoDesign Directive
- Compliant to standard IEC 60076-11
- Special products are available on demand



KEY BENEFITS

- Reduced partial discharges < 5pC: guaranteed reliability and optimised service life
- Reduced no-load and load losses (A0 -10% Ak): reduced energy consumption, compact dimensions, minimised noise level, lighter ferromagnetic core
- Dry-type transformer (technology): optimised environmental impact and maintenance
- Self-extinguishing: dry-type transformers that do not ignite



Visit our website

[legrand.com/datacenter/gb-en](https://www.legrand.com/datacenter/gb-en)

013

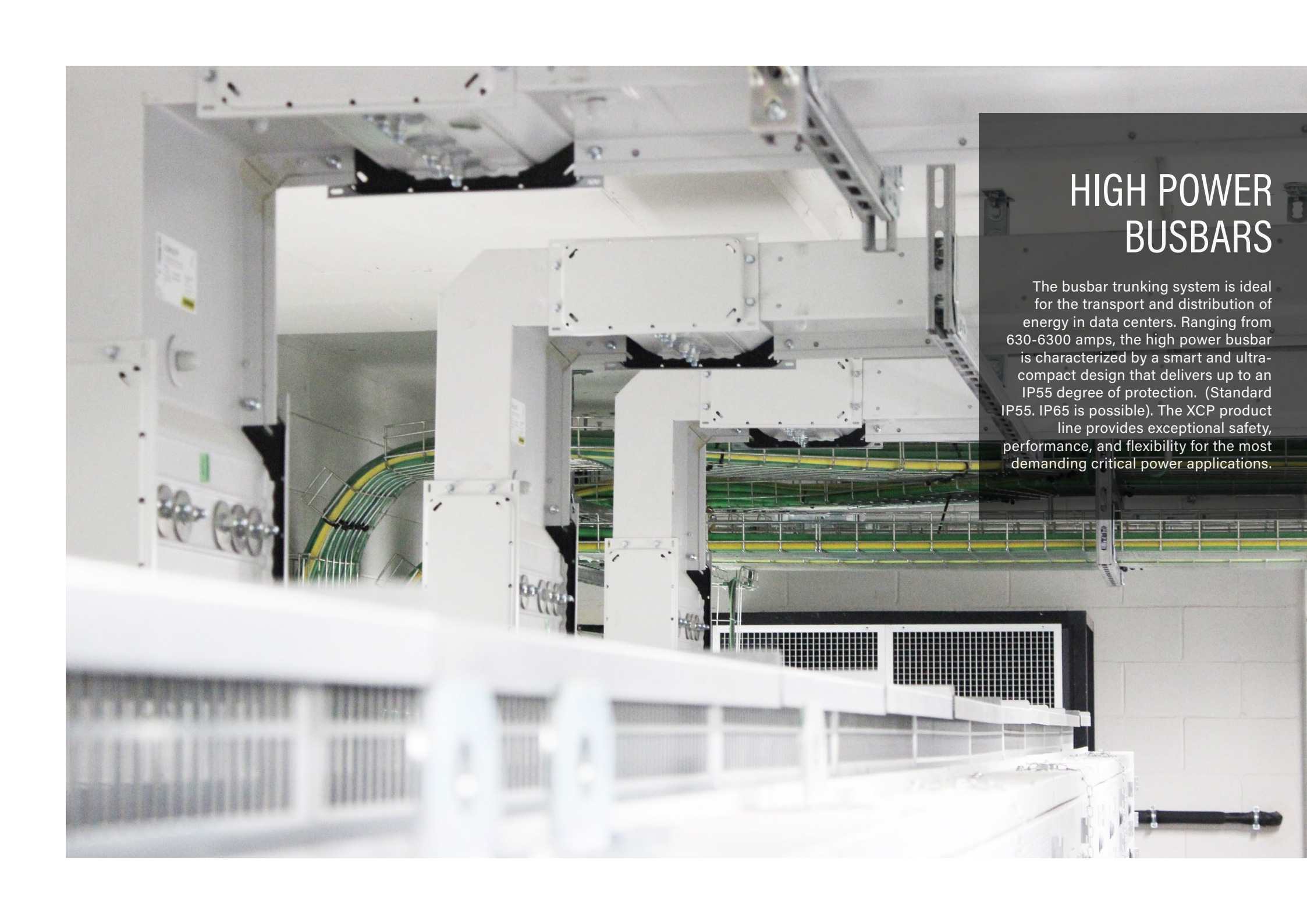

HIGH POWER BUSBARS

The busbar trunking system is ideal for the transport and distribution of energy in data centers. Ranging from 630-6300 amps, the high power busbar is characterized by a smart and ultra-compact design that delivers up to an IP55 degree of protection. (Standard IP55. IP65 is possible). The XCP product line provides exceptional safety, performance, and flexibility for the most demanding critical power applications.

XCP busbar is a compact, high performance busbar system, ready to meet the demand of power distribution in the modern data center. With a range of accessories, XCP is the perfect solution for energy distribution in the most simple or complex of applications.

FEATURES

- Fully rated, to an ambient temperature up to 55 degrees Celsius
- System with nominal amperage 630-6300 A, for continuous operation up to 1000 Vac
- Extra compact design with 3, 4 or 5 aluminium or copper conductors
- Variety of Tap off boxes in Interlocked metal or fiber glass up with 1250A
- Insulation classes B and F
- IP55 - IP65 and IP68 Degree of Protection models available
- Fully tested and compliance to standard EN61439-6

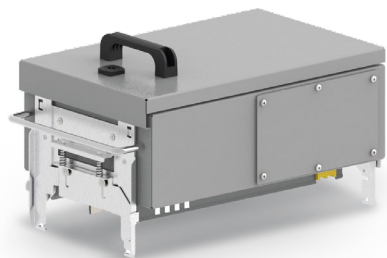
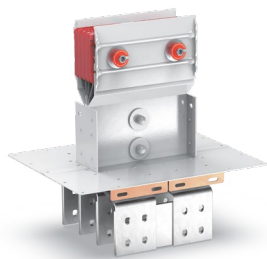

KEY BENEFITS

- Better efficiency in power distribution reducing voltage drops
- Proprietary PSSL software ensures fast and accurate layouts, bills of material and Hot Revit files
- AutoCAD and BIM models available
- Ease of installation and reduced installation time, with pre-installed MONOBLOC joint kits
- Safety assured: high rated short-circuit current, superior technology and fire resistance



Visit our website

[legrand.com/datacenter/gb-en](https://www.legrand.com/datacenter/gb-en)

SWITCHEARS

Legrand offers you a complete product portfolio with measuring units, MCCBs and ACBs up to 6300A, that enables maximum protection and efficient reliable power, by remaining energy efficient in critical power environment.



Legrand offers ACBs and MCCBs, for complete circuit protection, operator safety, energy efficiency and reliability in critical power environments.

DMX³ and DPX³ protection devices have a range of trip units and auxiliaries for intelligent switching.



FEATURES

DMX³ ACBs 630A to 6300A

- Four breaking capacities: 42 kA, 50 kA, 65 kA 100 kA
- All DMX³ breakers are factory equipped with with embedded energy measurement protection units
- Innovative and user-friendly touch screen tripping units
- Full range of fast clip control accessories

DPX³ MCCBs from 16A to 1600A

- Four breaking capacities: 36kA, 50 kA, 70kA 100kA
- Thermal magnetic including embedded energy measurement

All Protection devices:

- 3 or 4 pole options
- Optional integrated metering
- Fixed, plug in or withdrawable options

KEY BENEFITS

Continuity of Services and Increased safety across the range of Legrand protection devices:

- Circuit protection Selectivity between DPX³/DMX³ electronic circuit breakers
- Full compliance with EN/IEC standard 60947-2 and 60947-3
- European Directives REACH, ROHS, RAEE and PEP (Environmental Product Profile) available



Visit our website

legrand.com/datacenter/gb-en



UPS SOLUTIONS

Legrand is one of the biggest UPS manufacturer with the highest growth rate on the market. Legrand provides high-added value power solutions that guarantee energy-efficiency thus improving data center PUE (Power Usage Effectiveness) together with higher Uptime at maximum availability. Extended products portfolio able to fulfill the customer's unique and demanding critical power requirements.

Today, with a view to technological development that respects the environment and in order to face a constantly evolving market, Legrand proposes a UPS range, a complementary offer of technological functions able to guarantee maximum protection for all systems.

FEATURES

- Efficiency up to 97,2% in online mode
- True hotswap and hotscalable solutions
- Reduced footprint
- Low MTTR for maintenance
- Optimised TCO
- XaaS : Everything as a service
- Battery life optimisation technology
- Integrated protection and switching

KEY BENEFITS

- **RELIABILITY:** Integrated protection, true hot-swap, and fast & hot service for dependable power solutions.
- **HIGH AVAILABILITY:** True hot-swap capability ensures uninterrupted power supply with efficient and reliable service.
- **SCALABILITY:** 'Pay-as-you-grow' hot-scalable solutions adapt to evolving needs for flexible and scalable power systems.
- **ADAPTABILITY:** Overcome room constraints with extreme layout flexibility for adaptable and versatile power solutions.
- **LOW ENVIRONMENTAL FOOTPRINT:** Achieve up to 97.2% efficiency, even in low loads, with an eco-design approach for sustainability.
- **COMPACTNESS:** Benefit from a reduced footprint for space-efficient power solutions.
- **OPTIMIZED TCO:** Low MTTR for maintenance, battery life optimization, and retrofittable power modules for cost-effective operation.
- **COMPLETE RANGE:** From Single-Phase to High-Power Scalable Range, including battery cabinets and UPS management systems.



Keor MOD

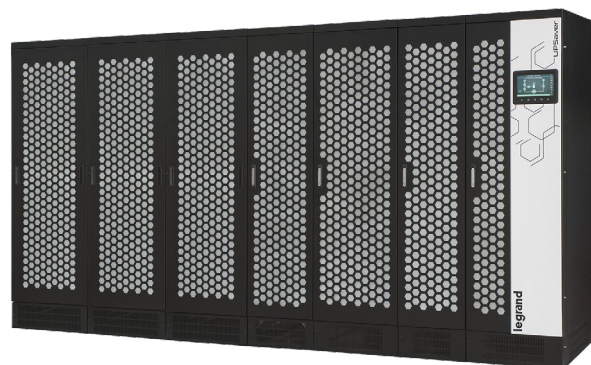

UPSaver



Keor XPE



Keor HPE



Visit our website

[legrand.com/datacenter/gb-en](https://www.legrand.com/datacenter/gb-en)



STS SOLUTIONS

Borri Static Transfer Switches enables seamless load transfer in dual power systems with enhanced logic management. With higher overload capability and enhanced safety, Borri STS is the optimum solution for critical loads where redundancy is essential.

Static Transfer Switch series designed to offer solutions for the protection of loads by increasing resilience one step higher by switching between available grids instant transfers for secure power switching without cross connection between sources.

FEATURES

- From 100 A to 3000 A
- Automatic instant (<4 ms) transfers
- Secure power switching without cross connection
- SCR fault detection and backfeed protection
- Dual manual bypass
- Full front access for easy maintenance
- Bottom and top cable entry
- Fully compliance with international standards



Borri STS 630A

KEY BENEFITS

- Short circuit protection
- No break seamless transfers
- High overload capability
- High fault current management
- High availability
- High availability
- Minimum maintenance costs



Visit our website

legrand.com/datacenter/gb-en



TRACK BUSWAY

Starline Track Busway is the industry-leading electrical power distribution system for data centers. One of the advantages, with the Starline systems, is the on site quality labs, to ensure design specification requirements for product reliability.

Starline.

With more than 90 years experience in busway power distribution, Starline is a worldwide industry leader in systems solutions for power distribution. Starline provides innovative, customizable power distribution and monitoring solutions that are particular to each customer's critical requirements. We are committed to enduring worldwide partnerships, with the highest level of customer service. Our unique U shaped copper busway system, creates constant tension across all joints and tap off points, offering the DC operator a safe and reliable distribution system Being UL, IEC, ETL listed and CE marked, the Starline busway can be used anywhere in the world.

FEATURES

- 100ka ICC rated busway system
- 250A - 1250A 4 pole and 5 pole systems
- Independently certified for live tap off insertion
- Preventative cable termination maintenance with optional end feed temperature monitoring
- Temperature monitoring
- All tap offs compatible across busbar range
- Compression joint assembly, no torquing of bolts
- Certified to BSEN 61439-6



Visit our website

[legrand.com/datacenter/gb-en](https://www.legrand.com/datacenter/gb-en)

KEY BENEFITS

- Maintenance Free busbar system, reduced TCO
- Customisable tap off options, to meet customer requirements
- U-shaped copper busbars: continuous and reliable connection
- Options: integration of metering accessories and value-added accessories (server cabinet mounting brackets, infrared (IR) windows)
- Scalable design for spreading CAPEX
- Increased redundancy and flexibility. Continuous access busway gives the operator, the ability to add or remove cabinets in a live environment.
- Easily identify power streams, within the data hall, by means of colour indication on the busbars.

023

CABLE MANAGEMENT

OVERHEAD CABLE MANAGEMENT

A robust, versatile cable management solution for installations of almost any size. Cablofil steel wire cable tray is supplied in straight lengths from which sophisticated installations can be created without the need for additional fittings.

EZ-PATH FIRE RESISTANT DEVICE

This versatile permanent automatic firestop system is suitable for any structure from concrete walls to lightweight partitions.



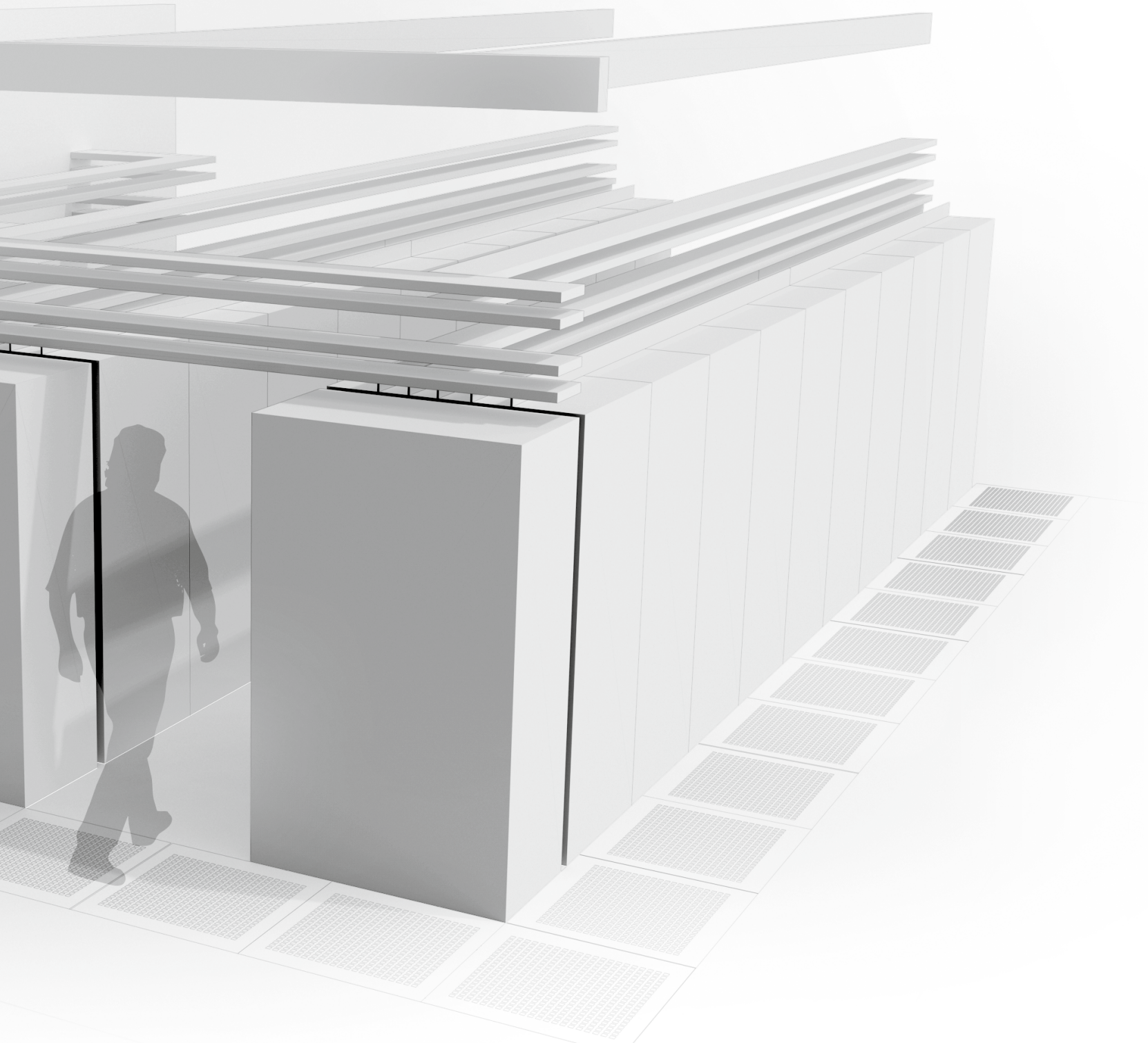

025

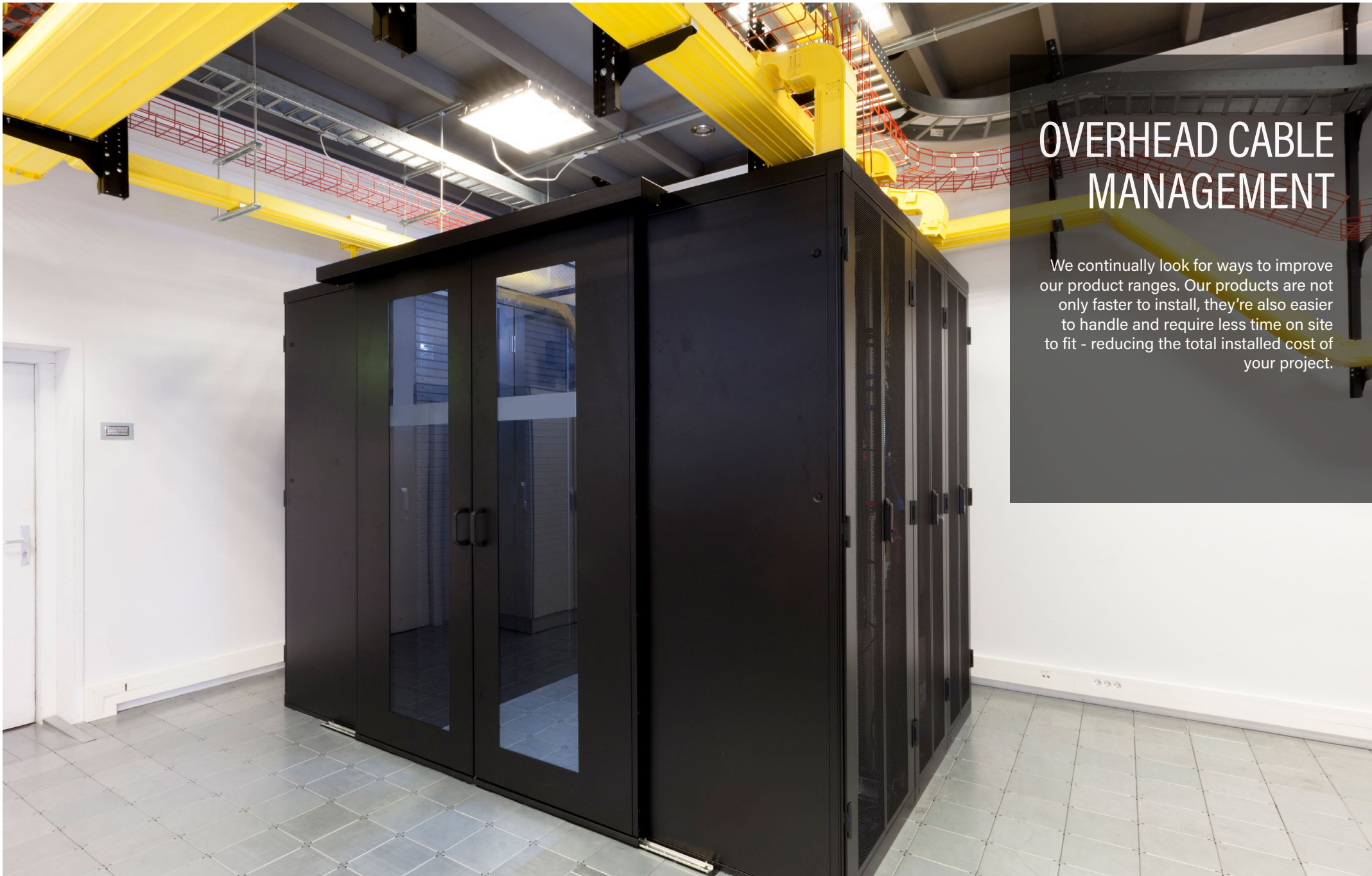

OVERHEAD CABLE MANAGEMENT

We continually look for ways to improve our product ranges. Our products are not only faster to install, they're also easier to handle and require less time on site to fit - reducing the total installed cost of your project.

CABLE STEEL WIRE TRAY

Cablofil steel wire cable tray is supplied in straight lengths from which sophisticated installations can be created without the need for additional fittings. Simply cut and shape lengths to form bends, tees, crosspieces etc. and secure quickly and easily using a range of 'slot and tab' fixings that do not require nuts and bolts.

FEATURES CABLE TRAY

- Cablofil cable tray®
Reach 2 m pre-stretched safety edge
- Sheet metal cable tray P31 Auto®
Reach 2 m pre-extended robustness
- Machine / envelope connections
- Fiber and copper dropouts and weirs
- Optimised cable ventilation: reduced heating
- EZ-Path fireproof device
- Visual differentiation of circuits:
time-saving, risk reduction...

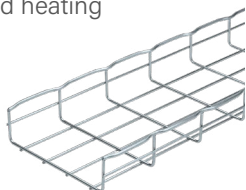

FIBER RACEWAY

Dedicated to fiber data distribution & protection, the Fiber raceway is the ideal solution to ensure an optimal optical fiber cabling and a highly efficient network at all times.

FEATURES FIBER RACEWAY

- Yellow cable management protection system against compression and bend radius
- Low smoke Zero Halogen and fully recyclable material (Nory)
- Easy & time saving installation

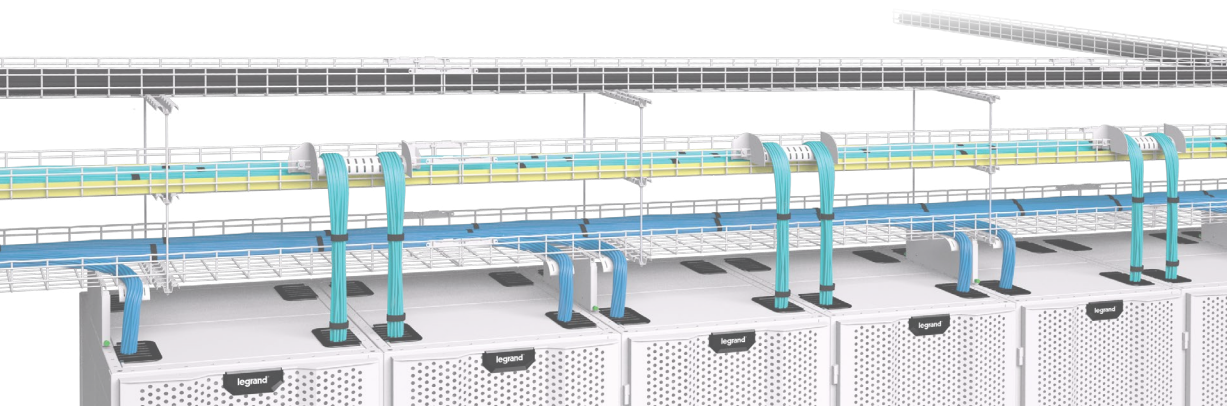
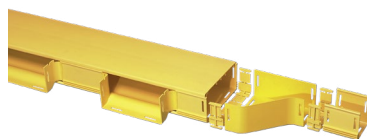

KEY BENEFITS

- A Legrand cable tray offer specially designed for data centers
- Suitable support systems
- Complete system of branching and marking components



Visit our website

[legrand.com/datacenter/gb-en](https://www.legrand.com/datacenter/gb-en)

EZ-PATH FIRE RESISTANT DEVICE

EZ-Path is a mechanical device that provides fully compliant fire stopping for power and data cable management pathways. It is easy to fit or retrofit and does not require a specialist fire contractor for system installation or maintenance.

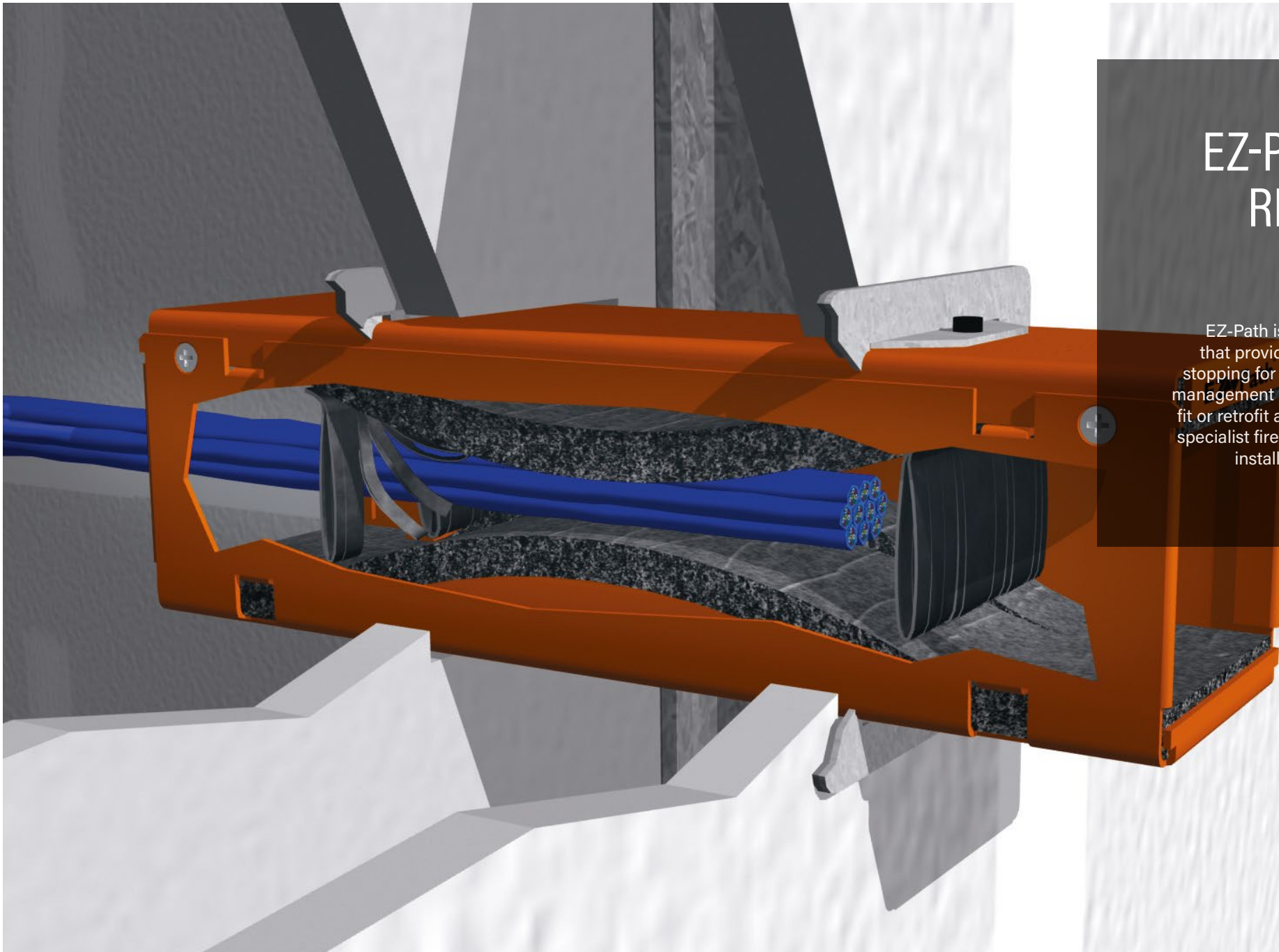

This versatile permanent automatic firestop system is suitable for any structure from concrete walls to sandwich panel to flexible partitions.

FEATURES

- Firestop module consisting of a metal housing containing intumescent pads and, if necessary, combine with fixing plates.
- Floor or wall installation
- EI 120 according to EN13501-2



POSSIBILITY
OF CUSTOMIZED
CONFIGURATION

EI120
according to
EN13501-2

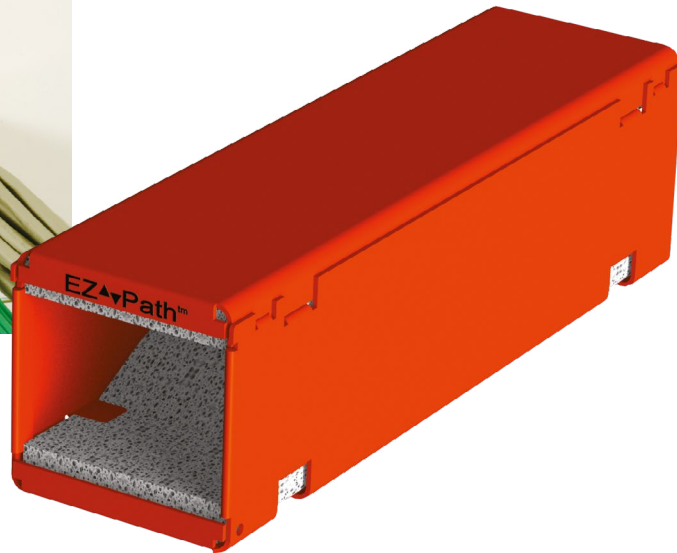

KEY BENEFITS

- Ensures compartmentalization
- Intumescent product expands in case of fire.
- Effective acoustic and smoke barrier
- The intumescent pads ensure support for the cables and maintain air tightness
- No sharp edges
- Automatically adjusts to cable loading
- Favourable cable management: scalability



Visit our website

[legrand.com/datacenter/gb-en](https://www.legrand.com/datacenter/gb-en)

EZ-Path® is a registered trademark and is manufactured by Specified Technologies Inc. (STI).

IT INFRASTRUCTURE

CONTAINMENT AND COOLING

Legrand offers high quality, modular and scalable containment and cooling solutions to optimize cooling and energy-efficiency through the separation of hot and cold airflows.

ACTIVE COOLING

Legrand provides a leading portfolio of active cooling solutions suitable for even the most demanding applications.

SERVER AND NETWORK RACKS & CABINETS

Premium cabinets with an extensive portfolio of accessories and solutions.

INTELLIGENT PDU'S AND SENSORS

PX Intelligent PDUs help eliminate human error and can withstand the harshest environments. With monitoring features that spot problems in advance and physical design elements that adapt to the toughest conditions, our solution protects your critical load under any circumstances.

KVM & SERIAL CONSOLE

Market leader in KVM solutions with a key focus in security, reliability and quality for your remote access needs.

STRUCTURED CABLING

Rising volumes of data exchanged, increasing numbers of networks, the need for higher speeds and the density of equipment make it necessary to have more reliable, secure, and highly-performing digital infrastructures. Legrand's structured cabling system is especially designed to meet these needs.

CONNECTIVITY FIBER SOLUTION

With increasing data rates, the fiber optic cabling systems currently available are reaching their limits. The attenuation budgets to be met as well as flexibility to adapt to new active components and cabling structures are obstacles that cannot be overcome.

DCIM SOFTWARE INTEGRATION

Reliable open architecture ensures full integration with your mission-critical DCIM solution.

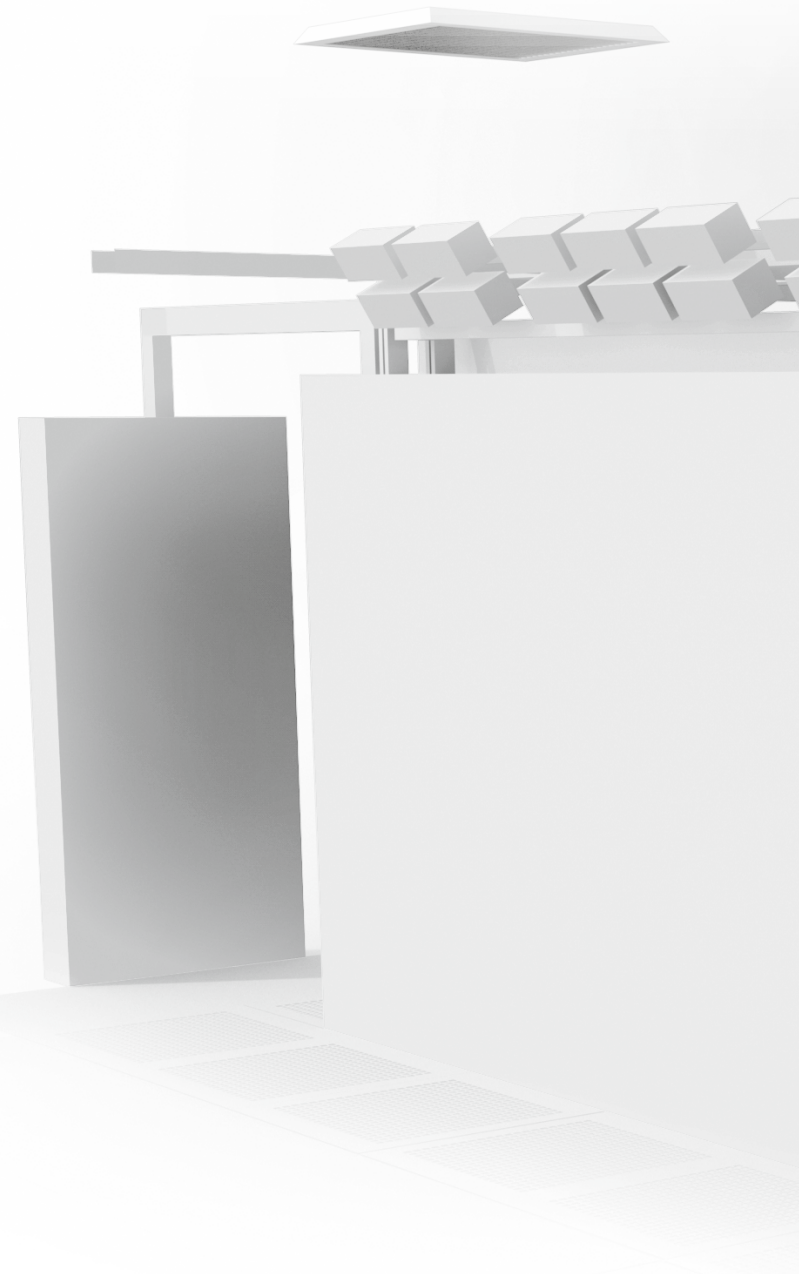

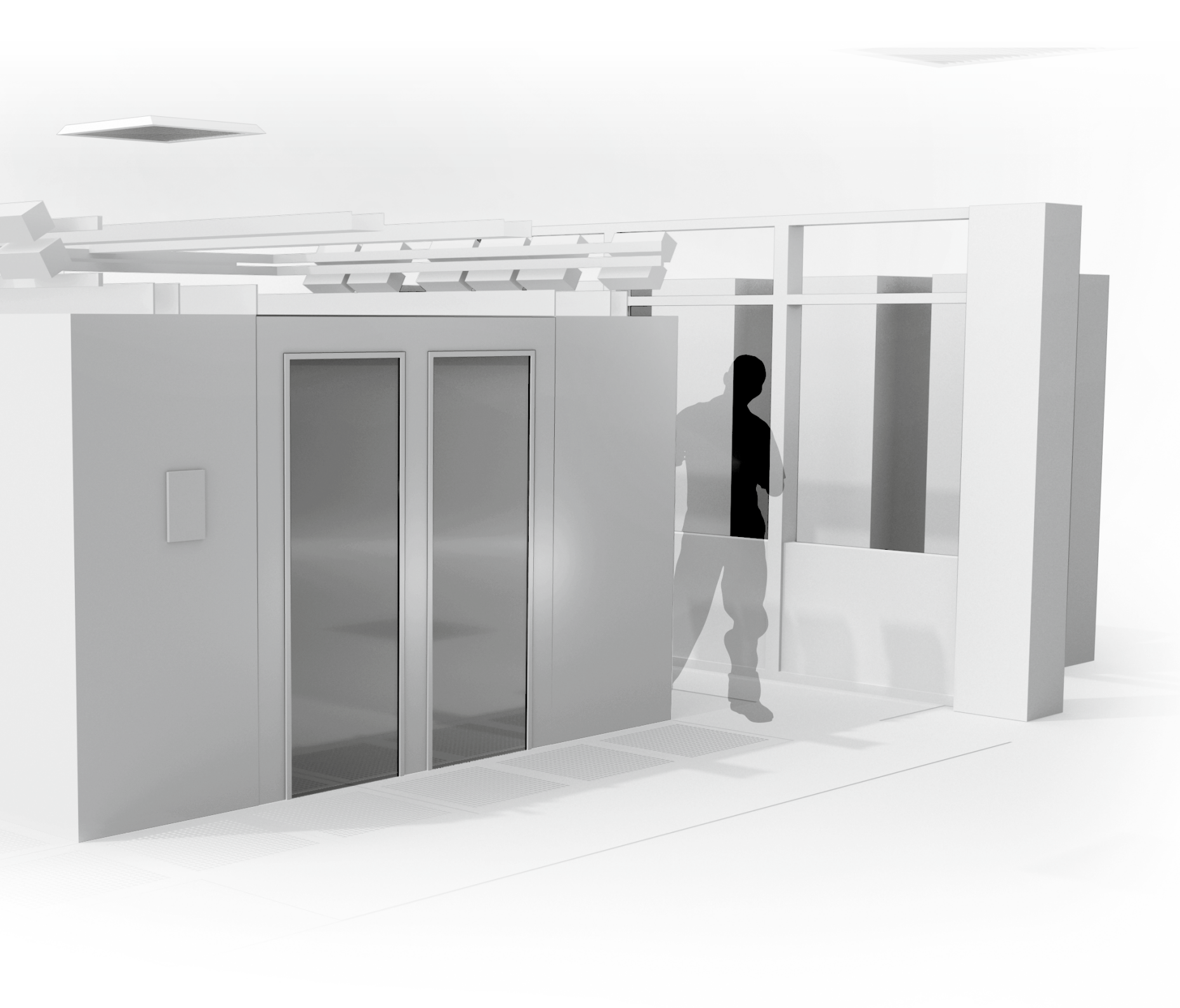

031



CONTAINMENT & COOLING

Legrand containment and cooling solutions guarantee an optimal temperature in the whitespace area and achieve energy-efficiency gains through the separation of hot and cold airflows.

PASSIVE COOLING

Passive cooling are the solutions where there is no mechanical device playing a part in the process besides possible CRAC units.

In this range, Legrand offers aisle containment, free-standing containment solutions ready to receive cabinets rolling in, vertical exhaust ducts that guide the hot airflows to a false ceiling and passive rear door coolers with zero operational costs.

FEATURES

- Customized design
- Optimal airflow management for better energy performance
- FM approved drop-away system for water fire extinguishing systems
- Optimised integration of cable management and busbars
- High transparency panels and LED lighting for best aisle visibility
- All containment options available for hot and cold containment layouts
- Passive rear doors compatible with most common cabinet dimensions in the industry

KEY BENEFITS

- A fully configurable solution adaptable to your needs, including IT equipment or constraints linked to the white space (poles, cable management, etc.)
- Free-standing easily fits different cabinet heights and provides better OPEX in multiphase projects
- Great cost effective solution for deployments where there are no high heat densities expected per cabinet

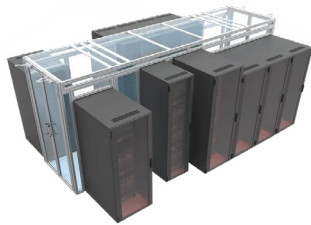

Custom containment within any complex environment

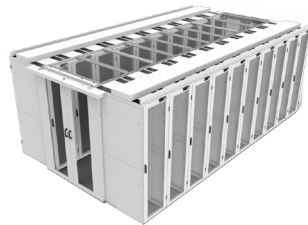

Standard containment



Scalable, self-supporting containment that adapts to growth with your data center

CL21 SmartPassive Rear Door Cooler



Vertical Exhaust duct

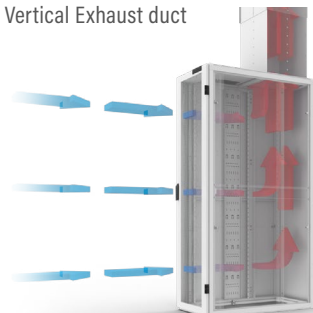

Visit our website

legrand.com/datacenter/gb-en

033



ACTIVE COOLING

Legrand provides a leading portfolio of active cooling solutions suitable for all requirements, large or small. Active cooling is close to the heat source, shortening the airflow path, decreasing the fan units' power consumption, and providing a fast and dynamic response by the coolers to changing heat densities.

ROW-BASED ACTIVE COOLING

The CW and DX row-based cooling solutions bring all the benefits of row-based cooling to the high density computing environment.

REAR DOOR COOLING

Chilled water cooling right at the rear of the cabinet for the most demanding IT applications

FEATURES

- Highly efficient row-based cooling portfolio
- Row-based coolers integrated in the Nexpan platform, compatible with most cabinet accessories.
- Highest cooling capacity in the market for rear doors
- Rear doors can be retrofitted in any existing installation
- The entire active cooling portfolio can be monitored and connected to any BMS

KEY BENEFITS

- A fully encompassed solution with precision row-based cooling modules up to 60kW
- Rear door coolers capable of delivering up to 200kW of cooling capacity per cabinet
- Technology capable of working with free cooling and achieving a PUE as low as 1,035



Row-based Chilled Water Coolers (CW)



Coldlogik CL20 and CL23 Rear Door Coolers

Row-based Direct Expansion Coolers (DX)



Visit our website

> legrand.com/datacenter/gb-en



SERVER/NETWORK RACKS & CABINETS

The racks & cabinets are perfectly suited for the installation of (blade) servers, switches, patch panels, routers and storage equipment. The racks & cabinets are used to bring together IT equipment and the corresponding cables neatly in one place, cables off all sorts ranging: PDUs, busbar, cable management... The racks & cabinets have everything to facilitate this in the best energy efficient and modular way.

MINKELS | modulan

Racks & cabinets are meant to outlive the IT equipment that is initially placed in them. That is why a customer should always wisely choose a product that will last more than 10 years. Legrand commits to this purpose with the Nexpan platform and the modulan customized open rack to make sure that no matter what the current or future needs are, they are covered from the moment the customer's cabinet requirement begins.

FEATURES

- Server and network racks & cabinets (19", 21", 23", ETSI) and integration cabinets, all in black and white
- Solid, glazed or perforated door
- Light weight and durable chassis
- The cable management system has the same flexibility as the chassis
- Wide range of accessories to cover many data center needs

KEY BENEFITS

- Optimal airflow management for better energy performance
- Fully modular design for total adaptability to your IT equipment
- Vast portfolio of cable management accessories
- Many accessories inside the rack
- Modular roof design
- Adjustable vertical mounting profiles
- 19 inch solutions available in 560mm wide SE racks to allow more cabinets in same aisle footprint

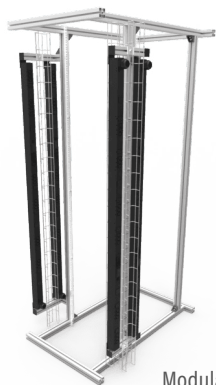

Modulan SE rack

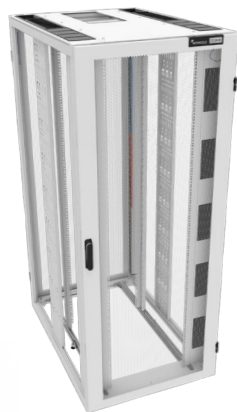

White Nexpan cabinet with airflow management package

NEXPAND



Black Nexpan cabinet with airflow management package



Visit our website

[legrand.com/datacenter/gb-en](https://www.legrand.com/datacenter/gb-en)

037



INTELLIGENT PDUS AND SENSORS

Intelligent PDUs are architected with components, features, and failsafes that ensure the most reliable infrastructure possible, both now and for years to come. Sensors are deployed as plug-and-play options for intelligent rack PDUs. Environment data is instantly sent to a DCIM software solution. A simple web-based interface allows data center managers to see real-time environment data and report trends over time.

PDUs are the last step between the IT equipment and the facility. This also means, it is the last place where you can place intelligence and have a standardized way of managing and monitoring the infrastructure. Raritan and Server Technology are leaders in the intelligent PDU market, providing the best solutions to ensure the most critical aspects of a data center, uptime and business continuity.

FEATURES

- Single or three phase, up to 67kVA, measurement with +/- 0.5% prediction
- Measurement and switching at the strip, circuit, socket
- Colour coding for easy identification of power supplies
- Integrated management of humidity, temperature, leakage and door opening sensors, as well as electronic locks
- Built-in failover power, residual current monitoring, USB mass configuration, alternating phases per branch or outlets and more
- Supports networked SNMP, MODBUS, open REST based API's and Redfish API

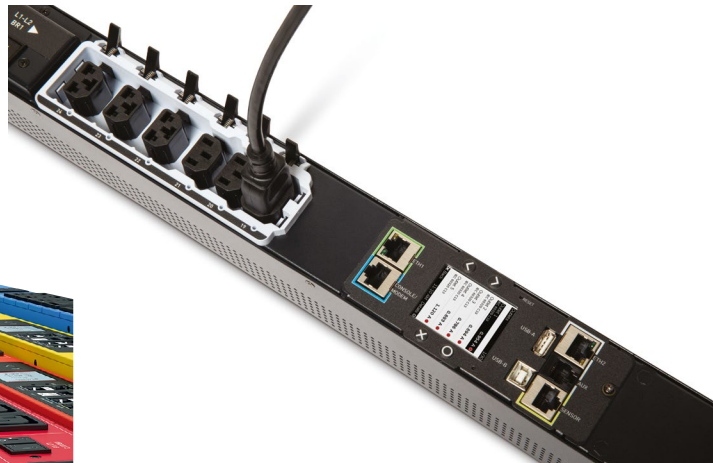
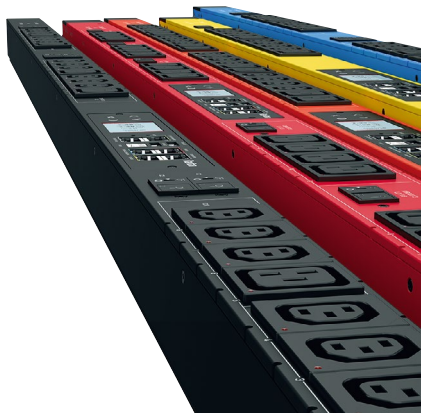

Visit our website

> [legrand.com/datacenter/gb-en](https://www.legrand.com/datacenter/gb-en)

039



KVM & SERIAL CONSOLE

Market leader in KVM solutions with a key focus in security, reliability and quality for your remote access needs. Raritan provides a variety of KVM-over-IP Switches that leverage today's Ethernet and TCP/IP networks to provide anytime/anywhere remote access, control and management.

Raritan®

In a world where the capability of working remotely has evolved from a nice-to-have to a must, Raritan continues to provide the best-in-market premium solutions to enable so with over 30 years of experience in KVM solutions.

FEATURES

- High performance video engine with 1920x1080/1200 video resolution, 30 FPS and 50 ms latency
- VGA, DVI, HDMI & DisplayPort video
- Up to 64 ports models for 8 remote IP sessions
- New best performing solution for 4K video resolution, 60 FPS and 3 monitors
- KVM view mobile app for iPhone/iPad
- Java-Free access
- CommandCenter centralized management to access thousands of devices under a single IP and remote management interface

KEY BENEFITS

- Remotely support computer and networking devices
- Ensure business continuity by quickly fixing problems and restoring service
- Eliminate or reduce travel needs
- Ensure personal safety
- Increased productivity by accessing hundreds, even thousands of computers from your desk
- Secure, encrypted and logged access to computer servers to ensure security



Visit our website

legrand.com/datacenter/gb-en

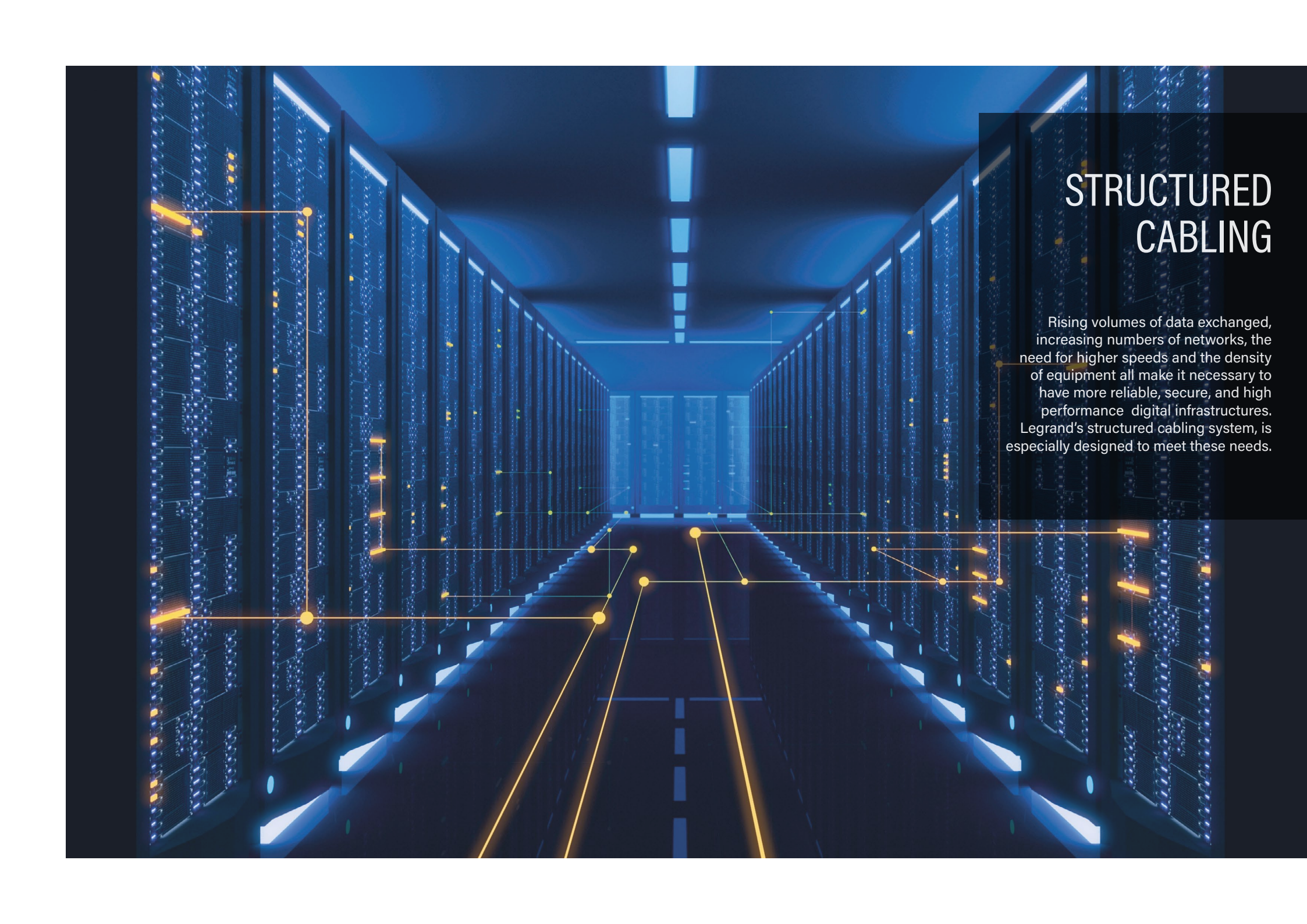
A perspective view of a server room aisle. The server racks on both sides are illuminated with a cool blue light, and their front panels feature numerous small, glowing blue lights. The floor is dark with a dashed white line running down the center of the aisle. Overlaid on the scene is a network diagram consisting of yellow lines and nodes, representing data connections between various points in the server room.

STRUCTURED CABLING

Rising volumes of data exchanged, increasing numbers of networks, the need for higher speeds and the density of equipment all make it necessary to have more reliable, secure, and high performance digital infrastructures. Legrand's structured cabling system, is especially designed to meet these needs.

Legrand is a world leader in communication networks for data transmission. Its investment in the development and design of structured cabling solutions enables the Group to expand its offer to remain at the highest level of performance for data centers and smart building installations.

FEATURES

- High quality modular solutions, supporting today's higher speeds and densities. Available in 1U/2U/4U
- Futureproof: 400Gb and beyond without redesign or preventing obsolescence with better optical performances (Infinium acclAIM, LCS3)
- Solutions with slim cassettes or without at all
- Integrated labeling options even with highest density

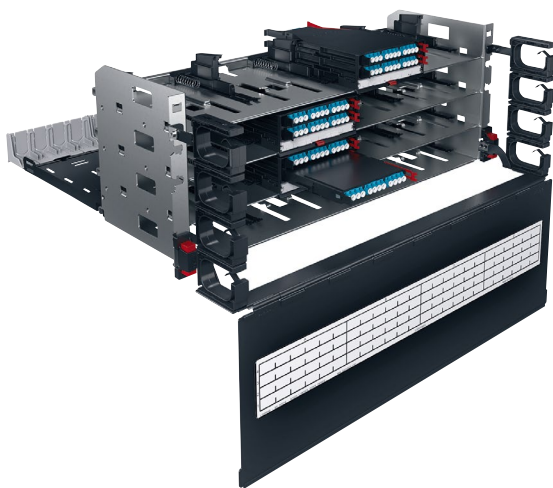

KEY BENEFITS

- Worldwide available, innovative data center solutions yielding industry leading performances
- Futureproof, easy migration to future network designs and technologies
- Easy and time-saving installation
- Easy maintenance with the rear and front optimized cable management



Visit our website

[legrand.com/datacenter/gb-en](https://www.legrand.com/datacenter/gb-en)



CONNECTIVITY FIBER SOLUTION

With increasing data rates, the fiber optic cabling systems currently available are reaching their limits. The attenuation budgets to be met as well as flexibility to adapt to new active components and cabling structures are obstacles that can be overcome.

Infinium acclAIM redefines connectivity by replacing preterminated cassette-based solutions with direct connections eliminating components, process, and cost. Infinium acclAIM delivers the only connectivity on the market with a near lossless link, almost unlimited scalability, and no gender considerations. The Direct Mating Breakout and Application Defined Polarity vastly improves density and flexibility and enables Sustainable Migration improving system life-cycle tremendously.

FEATURES

- Ultra-Low Loss, Total Channel loss ≤0,4dB
- Ultra high density, up to 288 fibre/U
- Simplify connectivity, No gender considerations - no pins, just direct connections
- Direct mating breakout - acclAIM connectors mate directly to an array of 2-fiber mdc duplex patch cords
- Application defined polarity

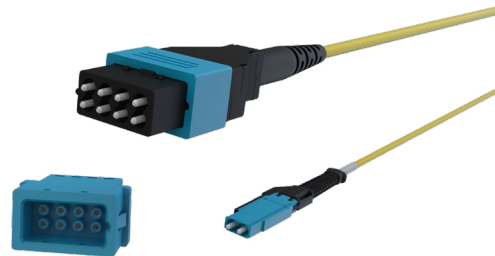

Current Cassette Based Architecture

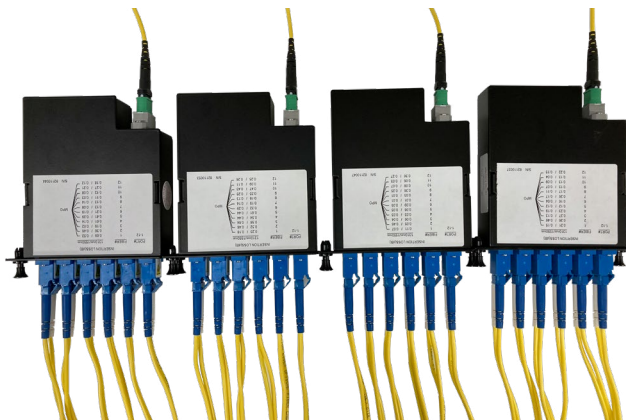

acclAIM Based Architecture

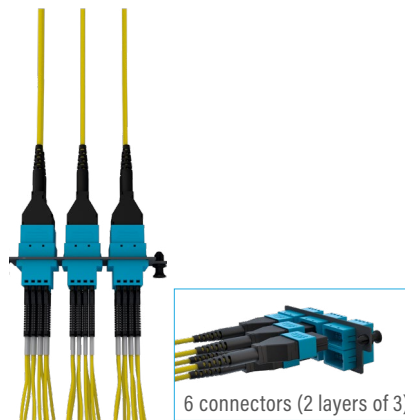

KEY BENEFITS

- Minimize loss - maximize optical headroom
- Eliminate cassettes – no cassettes needed due to direct mating
- Direct connection between multifibre and two-fibre transmission – No adaption needed

CUT COST.
CUT COMPLEXITY.
CUT CASSETTES.



Visit our website

legrand.com/datacenter/gb-en

DCIM SOFTWARE INTEGRATION

In today's data center, being efficient with power and cooling resources is almost as important as maintaining uptime. DCIM software provides the information and controls you need to fully utilize your existing infrastructure resources while alerting you to trouble before it causes downtime.



With support from Legrand’s experienced data center professionals, you will build a trusted database that becomes the single repository for all domains and levels – systems, network, facilities, managers, system administrators and technicians. A comprehensive DCIM solution will directly address the major issues of asset management, system provisioning, space and resource utilization and future capacity planning. Most importantly, it will provide an effective bridge to support the operational responsibilities and dependencies between facilities and IT personnel to eliminate the potential silos.

FEATURES

- Monitoring the use of the energy supply infrastructure
- Energy analyses, cooling diagrams and reports for loads, changes and capacity in real time at all levels of the infrastructure
- A configurable dashboard for a centralized view
- One-click access to all parameters for each rack, such as consumption, cooling, airflow, events...

KEY BENEFITS

- Real-time health monitoring
- Avoid hotspots and overcooling by tracking your sensor data in real-time
- Centralize your data center management and reporting
- Remote access control and access tracking



CUSTOMER SUCCESS STORIES

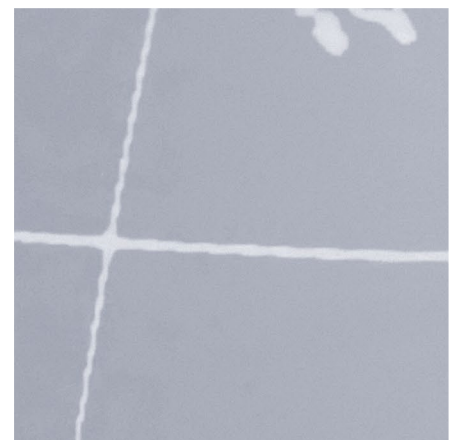
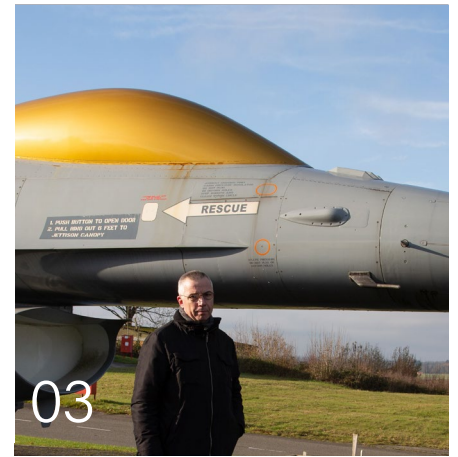
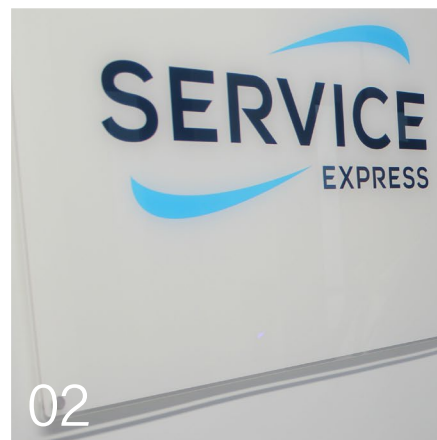
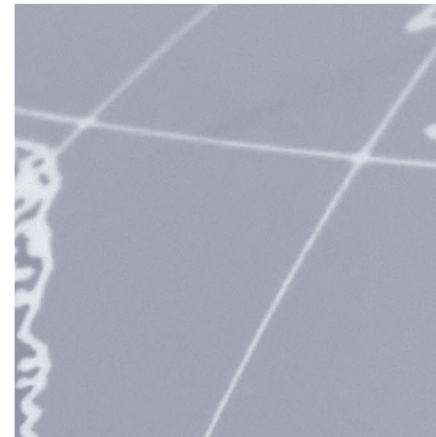
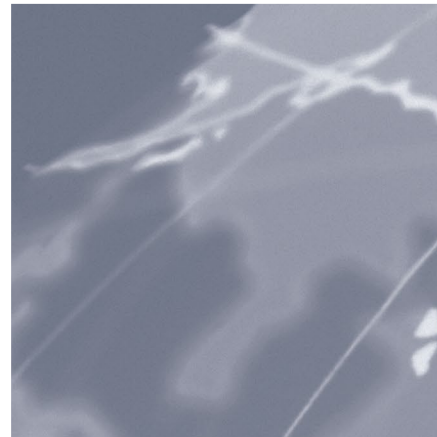

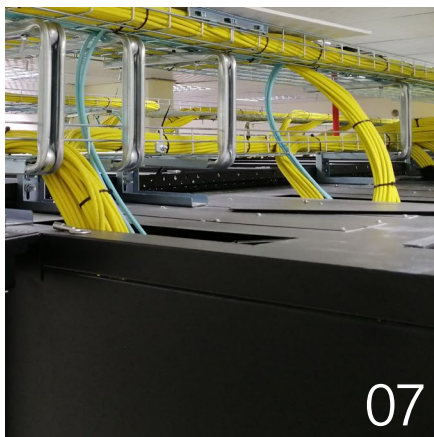
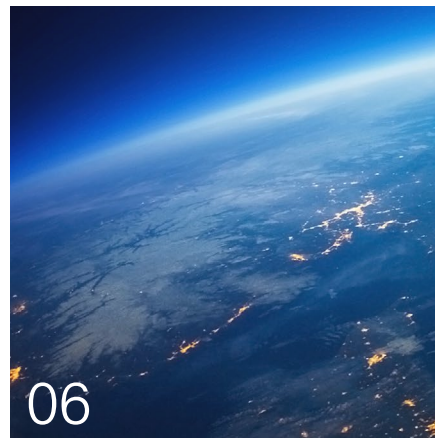
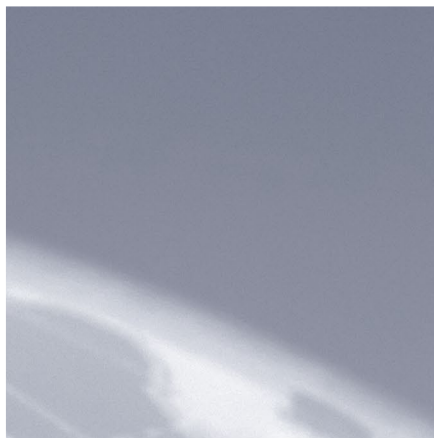

01 BAVARIAN STATE CRIMINAL POLICE OFFICE (BLKA) - GERMANY

02 SERVICE EXPRESS - UNITED KINGDOM

03 MINISTRY OF DEFENSE - BELGIUM

04 BULK - NORWAY

05 UNIVERSITY OF GRONINGEN (RUG) - THE NETHERLANDS

06 IOMART - UNITED KINGDOM

07 INTERNAL SECURITY FORCES - LEBANON

08 SEVEL CAR FACTORY - ITALY

09 INFRABEL - BELGIUM

10 MOVE-IT TECHNOLOGY - GERMANY

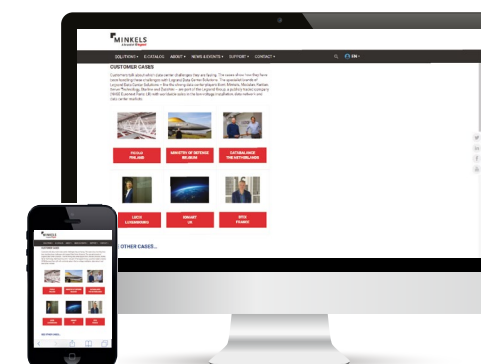

THANK YOU,
LETS STAY IN TOUCH!

 www.linkedin.com/company/legrand-data-center



WOULD YOU LIKE TO LEARN MORE?

Go to www.legrand.com/datacenter
or contact your local representative